

v.LiNK Video-inserter

VL2-CIC-F

**for BMW vehicles with
Business/Professional CIC-E and CIC-F series
navigation systems or radios with colour display
and 4pin HSD LVDS monitor plug**

Video-inserter with 2 video + RGB + rear-view camera input

Product features

- **Video-inserter for factory-infotainment monitors**
- **2 CVBS video-inputs for after-market devices (e.g. DVD-Player, DVB-T tuner, ...)**
- **Built-in audio-switch (no audio-insertion)**
- **Rear-view camera CVBS video-input**
- **Automatic switching to rear-view camera input on engagement of reverse gear**
- **Picture-in-picture (PIP) mode combining after-market rear-view and front camera picture(s) with factory parking sensor graphic**
- **Activatable parking guide lines for rear-view camera**
- **RGB-input for after-market navigation**
- **Video-in-motion (ONLY for connected video-sources)**
- **Compatible with factory rear-view camera**
- **AV-inputs PAL/NTSC compatible**
- **Ultra-wide picture mode 24:9 (only with ultra-wide screens 8.8" and 10.2")**

Contents

1. Prior to installation

- 1.1. Delivery contents
- 1.2. Checking the compatibility of vehicle and accessories
- 1.3. Boxes and connectors
 - 1.3.1. Video-interface
 - 1.3.2. CAN-bus box
- 1.4. Dip-switch settings (Video-Interface)
 - 1.4.1. Enabling the interface's video inputs (dip 1-3)
 - 1.4.2. RGB-video input signal selection for after-market navigation (Dip 4)
 - 1.4.3. Rear-view camera setting (dip 5)
 - 1.4.4. Monitor selection (dip 8)

2. Installation

- 2.1. Place of installation
- 2.2. Connection schema
- 2.3. Connecting video-interface and CAN-box
- 2.4. Connection to the factory monitor
- 2.5. Connecting peripheral devices
 - 2.5.1. After-market RGB navigation
 - 2.5.2. Video-sources to AV1 and AV2
 - 2.5.3. Audio-switch and audio-insertion
 - 2.5.4. After-market rear-view camera
 - 2.5.4.1. Case 1: CAN-box detects reverse gear
 - 2.5.4.2. Switching of picture formats – Activation PIP
 - 2.5.4.3. Case 2: CAN-box does not detect reverse gear
 - 2.5.4.4. Video signal connection
- 2.6. Picture settings and guide lines

3. Interface operation

- 3.1. By iDrive-buttons

4. Specifications

5. Frequently asked questions

6. Technical support

Legal Information

By law, watching moving pictures while driving is prohibited, the driver must not be distracted. We do not accept any liability for material damage or personal injury resulting, directly or indirectly, from installation or operation of this product. This product should only be used while standing or to display fixed menus or rear-view-camera video when the vehicle is moving, for example the MP3 menu for DVD upgrades.

Changes/updates of the vehicle's software can cause malfunctions of the interface. We offer free software-updates for our interfaces for one year after purchase. To receive a free update, the interface must be sent in at own cost. Labor cost for and other expenses involved with the software-updates will not be refunded.

1. Prior to installation

Read the manual prior to installation.

Technical knowledge is necessary for installation. The place of installation must be free of moisture and away from heat sources.

1.1. Delivery contents

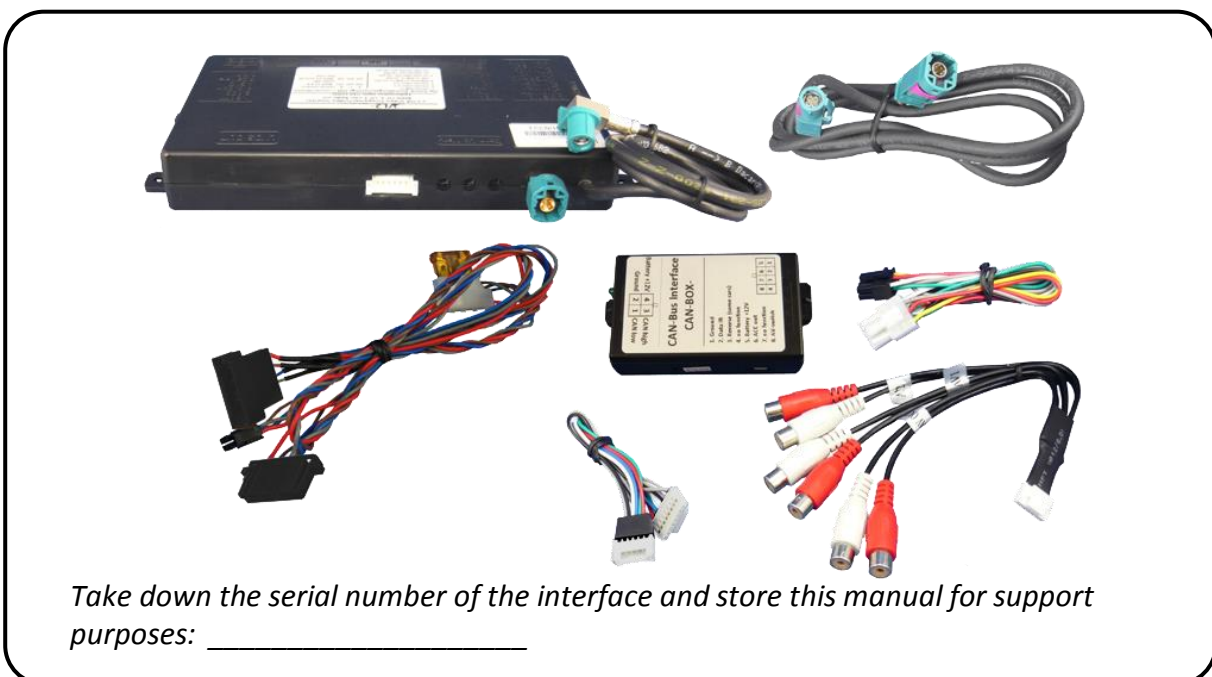

1.2. Checking the compatibility of vehicle and accessories

Requirements	
<i>Vehicle</i>	BMW 1series (E87), 3series (E90/91/92/93), 5series (E60/61/F10/F11), 6series (E63/64/F12/F13/F14), 7series (F01/F02), GT5 (F07), X1 (E84), X5 (E70), X6 (E71), Z4 (E89), Mini from about 09/2010 Only BMW F-series vehicles till approx 06/2012
<i>Head-unit/monitor</i>	Business/Professional CIC-E and CIC-F navigation systems or radios with colour display with 4pin HSD LVDS monitor plug
Limitations	
<i>Ultra-wide mode</i>	Only available for ultra-wide screens 8.8"/10.2"
<i>Video only</i>	The interface inserts ONLY video signals into the infotainment. For sound use the possibly existing factory-audio-AUX-input or a FM-modulator.
<i>Factory rear-view camera</i>	Automatic switch-back from inserted video to factory rear-view camera only while reverse gear is engaged. To delay the switch-back time, additional electronics is required.

1.3. Boxes and connectors

1.3.1. Video-interface

The video-interface converts the connected after-market sources video signals to an LVDS signal which is the inserted into the factory monitor on certain trigger options.

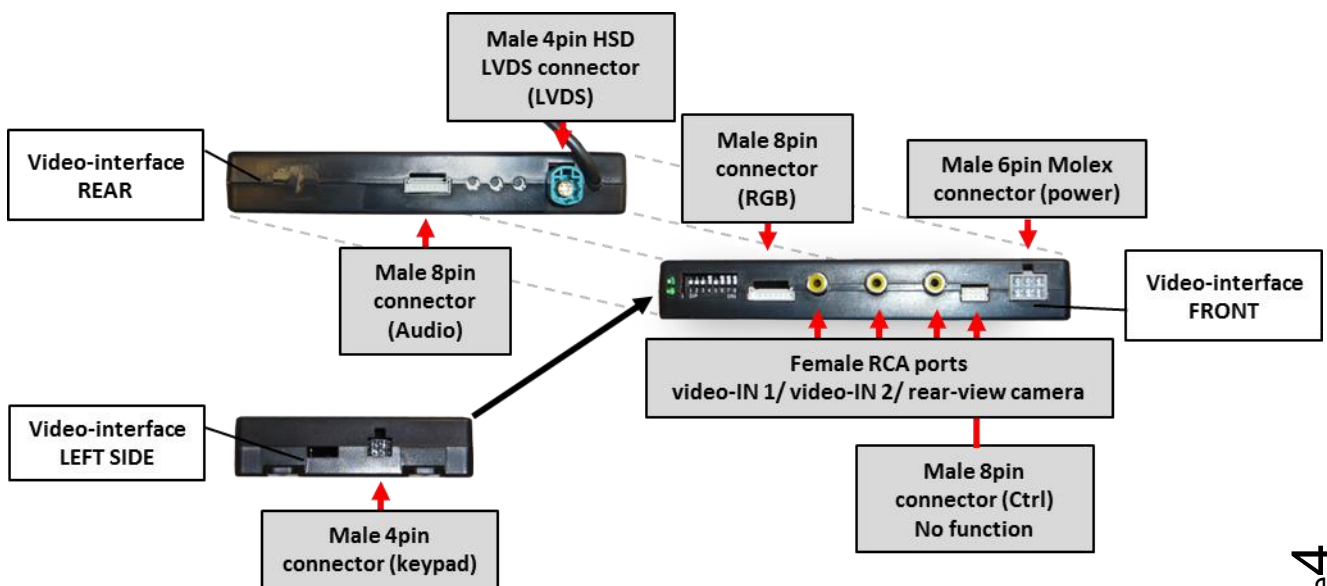

1.3.2. CAN-bus box

The CAN-bus box reads digital signals from the CAN-bus and converts them for the video-interface.

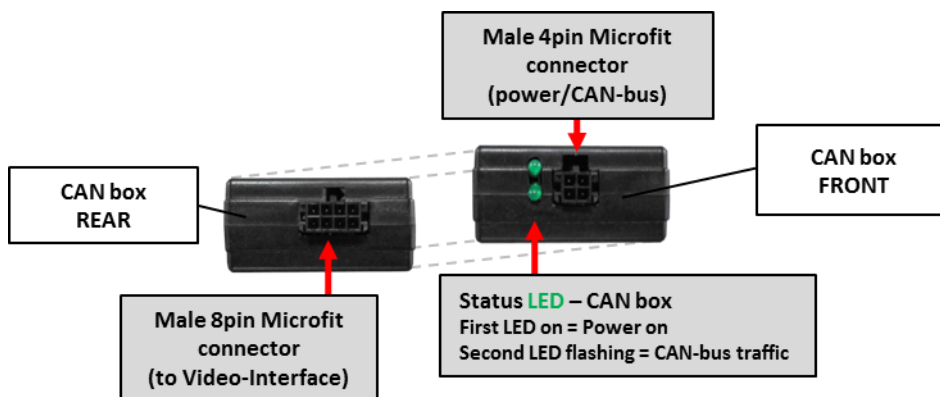

1.4. Dip-switch settings (Video-Interface)

Some settings must be selected by the dip-switches on the video-interface. Dip position down is ON and position up is OFF.

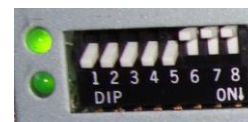

Dip	Function	ON (down)	OFF (up)
1	RGB-input	enabled	disabled
2	CVBS AV1-input	enabled	disabled
3	CVBS AV2-input	enabled	disabled
4	RGB-input resolution	VGA 800x480	NTSC 400x240 or 480x240
5	Rear-view cam type	after-market	factory or none
6	No function	-	set OFF
7	No function	-	set OFF
8	Monitor selection	Try the 2 possible settings of dip 8 to find the best picture (quality and size)	

See following chapters for detailed information.

1.4.1. Enabling the interface's video inputs (dip 1-3)

Only the enabled video inputs can be accessed when switching through the interface's video sources. It is recommended to enable only the required inputs for the disabled will be skipped when switching through the video-interfaces inputs.

1.4.2. RGB-video input signal selection for after-market navigation (Dip 4)

If an after-market RGB navigation or other RGB video source is connected, the source's RGB output signal must match the interface's RGB video input setting.

1.4.3. Rear-view camera setting (dip 5)

If set to OFF, the interface switches to factory LVDS picture while the reverse gear is engaged to display factory rear-view camera or factory optical park system picture.

If set to ON, the interface switches to its rear-view camera input CAM while the reverse gear is engaged.

1.4.4. Monitor selection (dip 8)

Dip 8 is for monitor-specific video settings which cannot be predicted as even within the same head-unit version, the monitor specifications may vary. It is necessary to try both possible combinations (8 ON and OFF) - while a working video source is connected to the chosen input of the interface - to see which setting gives the best picture quality and size (some may give no picture). It is possible to first hot plug through the dip combinations, but if you do not experience any change of picture after trying both options, retry and disconnected the 6pin power plug of the video-box between every change of the dip setting.

2. Installation

Switch off ignition and disconnect the vehicle's battery! The interface needs a permanent 12V source. If according to factory rules disconnecting the battery is to be avoided, it is usually sufficient to put the vehicle in sleep-mode. In case the sleep-mode does not show success, disconnect the battery with a resistor lead.

If power source is not taken directly from the battery, the connection has to be checked for being start-up proven and permanent.

2.1. Place of installation

The interface is installed on the backside of the factory monitor.

2.2. Connection schema

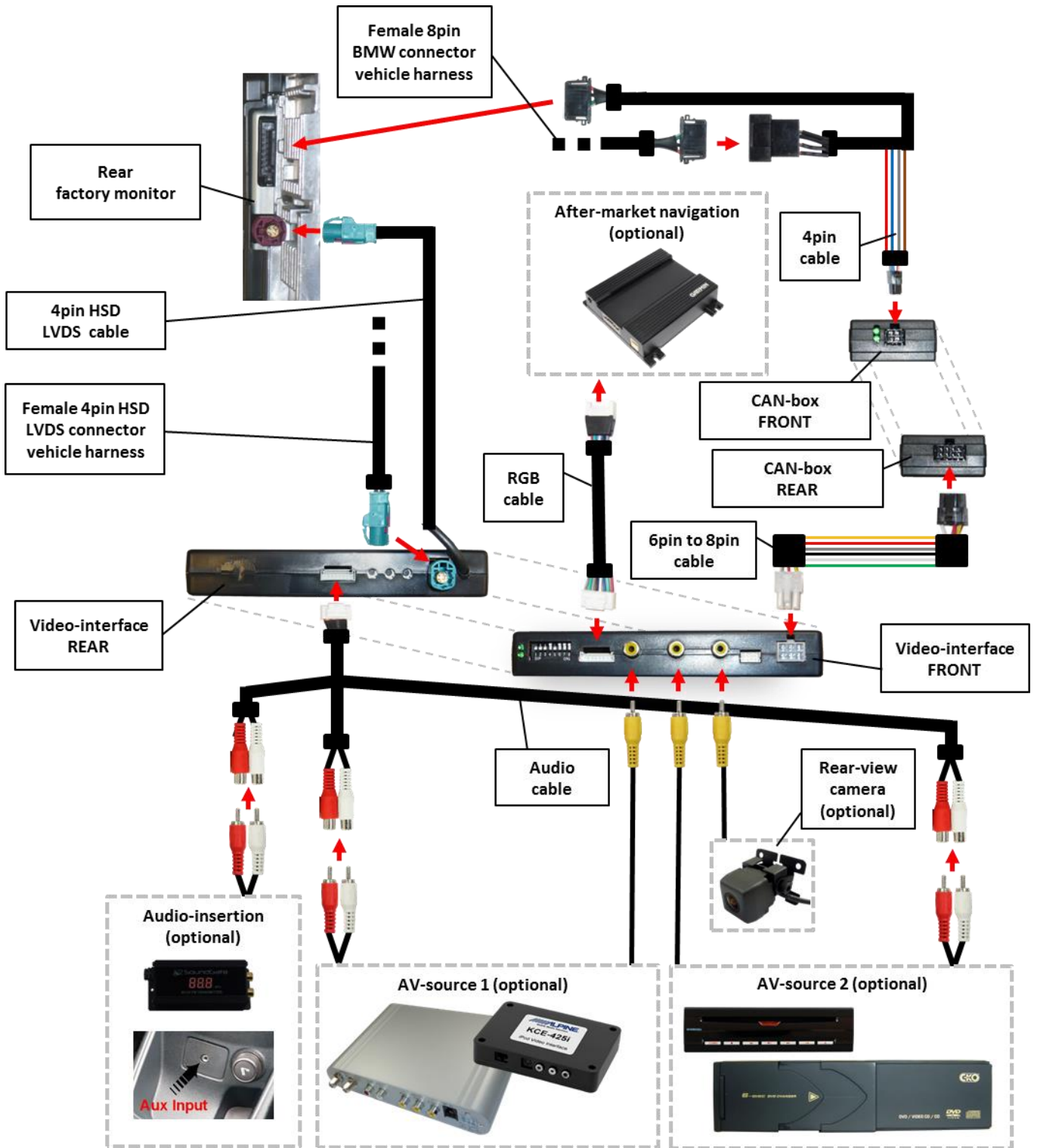

2.3. Connecting video-interface and CAN-box

The CAN-bus box reads digital signals from the CAN-bus and converts them for the video-interface. ACC +12V max. 0.5A (red of 6pin) and reverse gear +12V max. 0.5A (green of 6pin) constant signal. Video-source switching (white of 6pin) as +12V impulse.

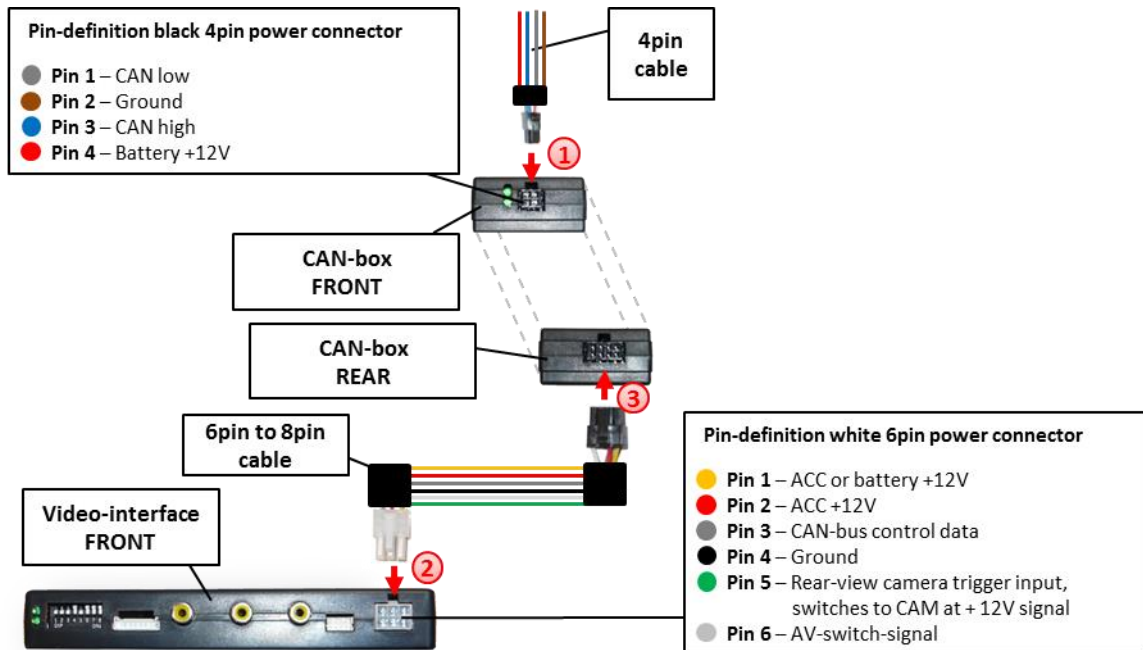

- ① Connect black female 4pin Micro-Fit connector of the 4pin cable to the male 4pin Micro-Fit connector of the CAN-box.

Note: Check LEDs on CAN-box after reconnecting the battery, one must be on.

- ② Connect white female 6pin Molex connector of the 6pin to 8pin cable to the male 6pin Molex connector of the video-interface.

- ③ Connect black female 8pin Micro-Fit connector of the 6pin to 8pin cable to male 8pin Micro-Fit connector of the CAN-box.

Note: Check LEDs on video-interface after reconnecting the battery, one must be on.

Note: The CAN-box is not compatible with all vehicles. If the CAN-box does not deliver ACC to pin2 of the video-interface or blocks the vehicle CAN, it is possible to install without CAN-box. In this case see also note in chapter after-market rear-view camera if one is supposed to be connected.

2.4. Connections to the factory monitor

Remove factory monitor.

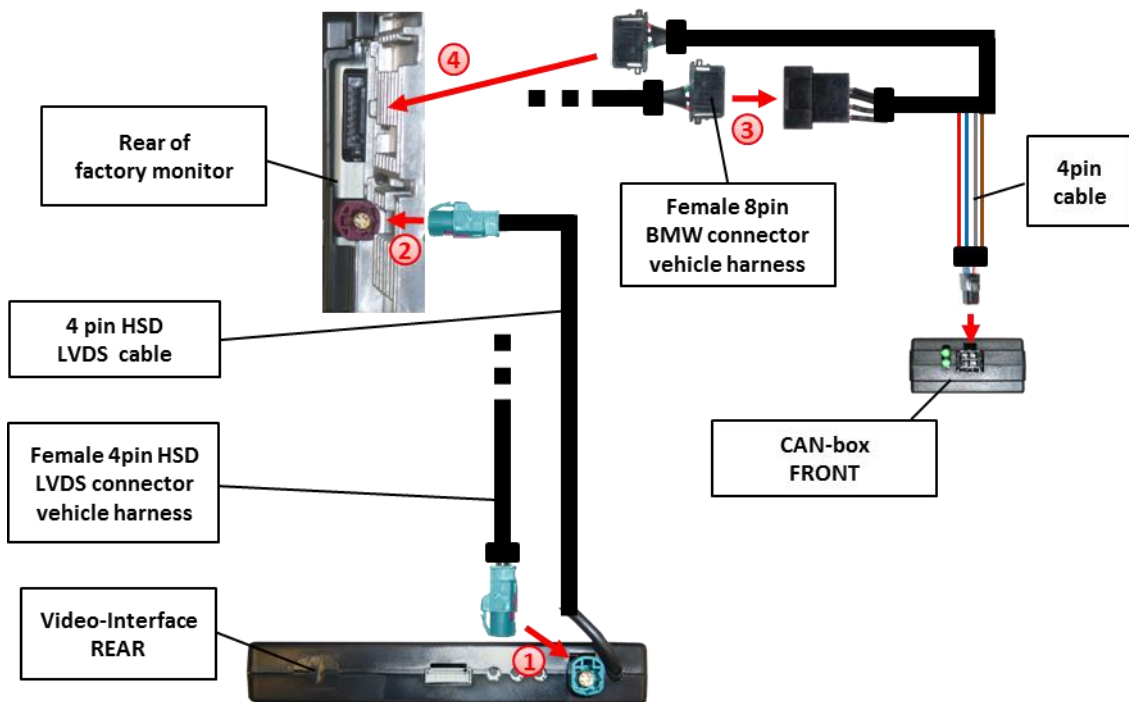

- ① Remove female 4pin HSD LVDS connector from the rear of the factory monitor and connect it to the male 4pin HSD LVDS connector of the video-interface.
- ② Connect female 4pin connector of the 4pin HSD LVDS cable to the male 4pin HSD LVDS connector of the factory monitor.
- ③ Remove female 8pin BMW connector of factory harness from the rear of the factory monitor and connect it to the male 8pin BMW connector of the 4pin cable.
- ④ Connect female 8pin BMW connector of the 4pin cable to the male 8pin BMW connector of the factory monitor.

2.5. Connecting peripheral devices

It is possible to connect an after-market navigation (or another RGB-source), two after-market AV-sources and an after-market rear-view camera to the video-interface.

Before final installation of the peripheral devices, we recommend a test-run to detect incompatibility of vehicle and interface. Due to changes in the production of the vehicle manufacturer is always the possibility of incompatibility.

2.5.1. After-Market RGB navigation

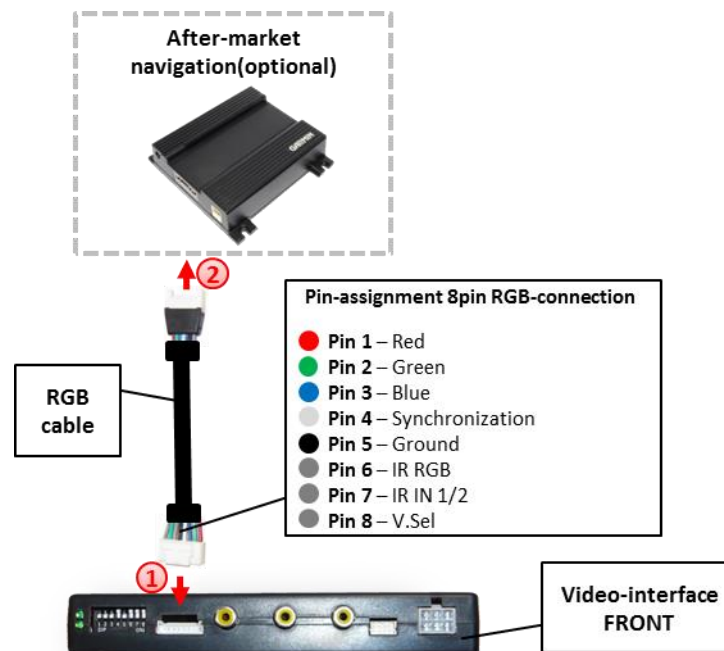

- ① Connect female 8pin connector of the RGB cable to the male 8pin connector of the video-interface. The loose grey wires have no function and have to be isolated.
- ② Connect male 6pin connector of the RGB cable to the after-Market navigation.

2.5.2. Video-sources to IN1 and IN2

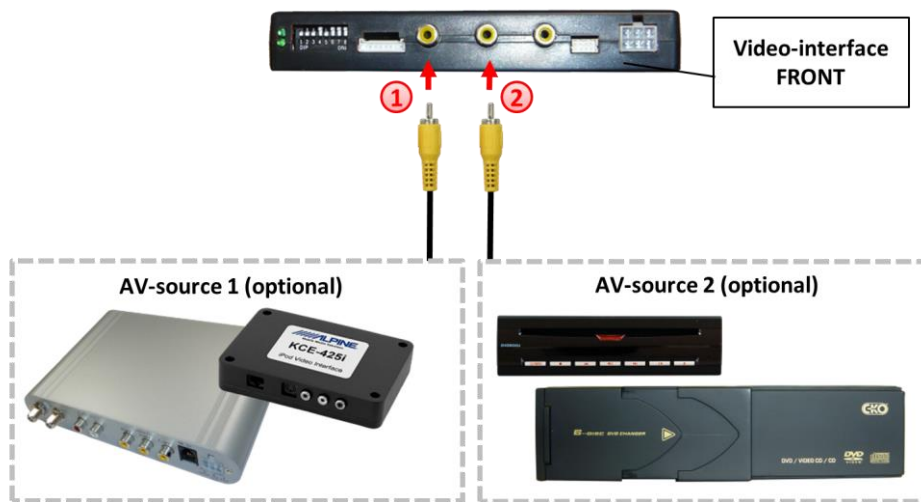

- ① Connect video RCA of the AV-source 1 to the female RCA connector IN1 of the video-interface.
- ② Connect video RCA of the AV-source 2 to the female RCA connector IN2 of the video-interface.

2.5.3. Audio-switch and audio insertion

This interface can only insert video signals into the factory infotainment and switch audio signals. If an AV-source is connected to AV1 or AV2, audio insertion must be done by factory audio AUX input or FM-modulator to which the interface's sound-switch output is connected. When the interface is switched from AV1 to AV2, the audio signal is switched parallel to the corresponding video signal by the interface's built-in audio-switch. The inserted video-signal can be activated simultaneously to each audio-mode of the factory infotainment.

Audio pins	Definition
1/2	Audio input signal R/L of source AV2
3/4	Audio input signal R/L of source AV1
5/6	Audio output signal R/L of factory audio AUX or FM-modulator
7	Ground

Note: If only one AV-source shall be connected, it is possible to connect the video output of the AV-source to the video input AV1 of the video-interface and the audio output of the AV-source directly to the point of audio-insertion (e.g. audio AUX input).

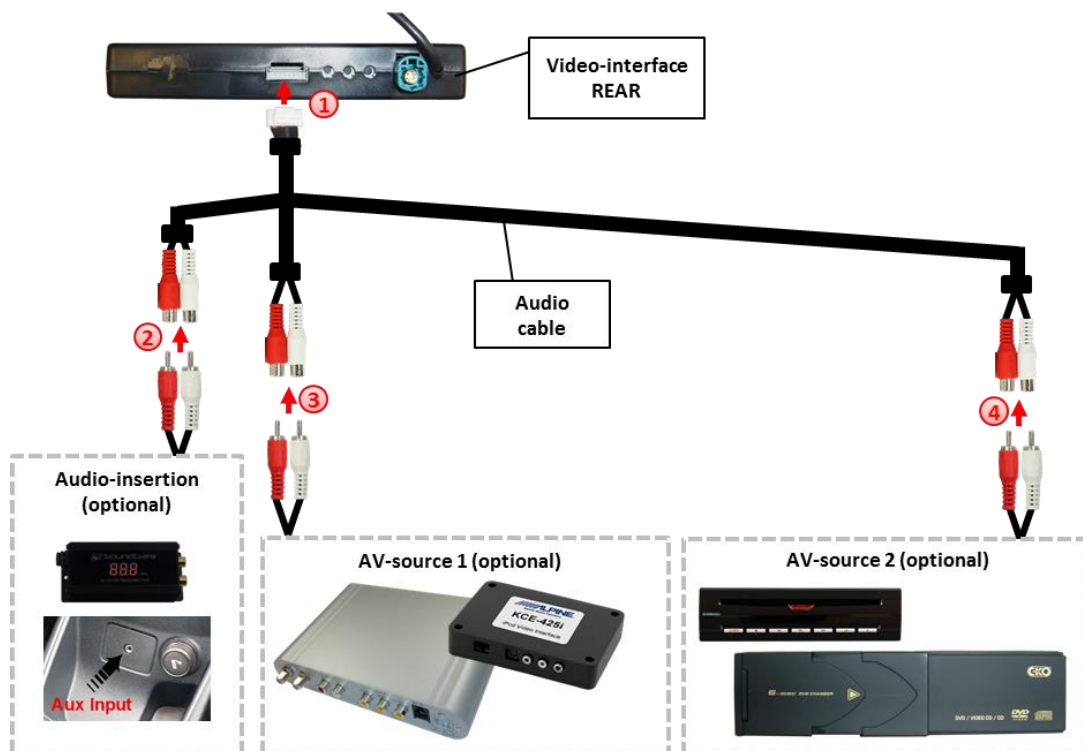

- ① Connect female 8pin connector of the audio cable to male 8pin connector of the video-interface.
- ② Connect the audio-RCA of the possibly existing factory AUX-input or the FM-modulator to the female RCA port AV-Out of the audio cable.
- ③ Connect the audio-RCA of the AV-source 1 to the female RCA port AV1 of the audio cable.
- ④ Connect the audio-RCA of the AV-source 2 to the female RCA port AV2 of the audio cable.

2.5.4. After-market rear-view camera

Some vehicles have a different reverse gear code on the CAN-bus which the included CAN-box is not compatible with. Therefore there is two different ways of installation. If the CAN-box can detect the reverse gear in the vehicle, the green wire of the 6pin to 8pin cable should carry +12V while the reverse gear is engaged.

Note: Do not forget to set dip5 of video-interface to ON before testing.

2.5.4.1. Case 1: CAN-box detects reverse gear

If the CAN-bus interface delivers +12V on the green wire of the 6pin to 8pin cable when reverse gear is engaged, the video-interface will automatically be switched to the rear-view camera input CAM while reverse gear is engaged.

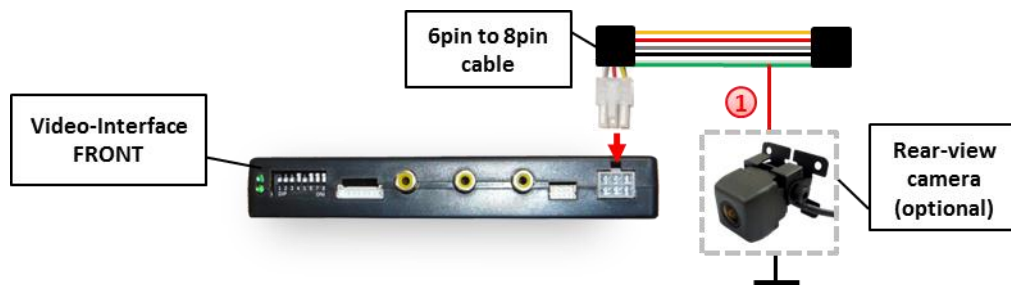

- ① Additionally, the +12V (max. 500mA) power supply for the rear-view camera can be taken from the green wire of the 6pin to 8pin cable.

2.5.4.2. Switching of picture formats – Activation PIP

Long press **OPTION**-button or long push **iDrive up** to switch the picture format:

- 16:9
- 24:9
- PIP vertical (combining after-market rear-view and front camera picture(s) with factory parking sensor graphic)
- PIP horizontal

Note: Picture formats 24:9 and PIP horizontal are only available for ultra-wide screens 8.8"/10.2".



2.6.1.1. Case 2: CAN-box does not detect reverse gear

If the CAN-bus interface does not deliver +12V on the green wire of the 6pin to 8pin cable when reverse gear is engaged (not all vehicles are compatible) an external switching signal from the reverse gear light is required. As the reverse gear light signal contains electronic interference, a normally open relay (e.g AC-RW-1230 with wiring AC-RS5) or filter (e.g. AC-PNF-RVC) is required. Below schema shows the use of a relay (normally open).

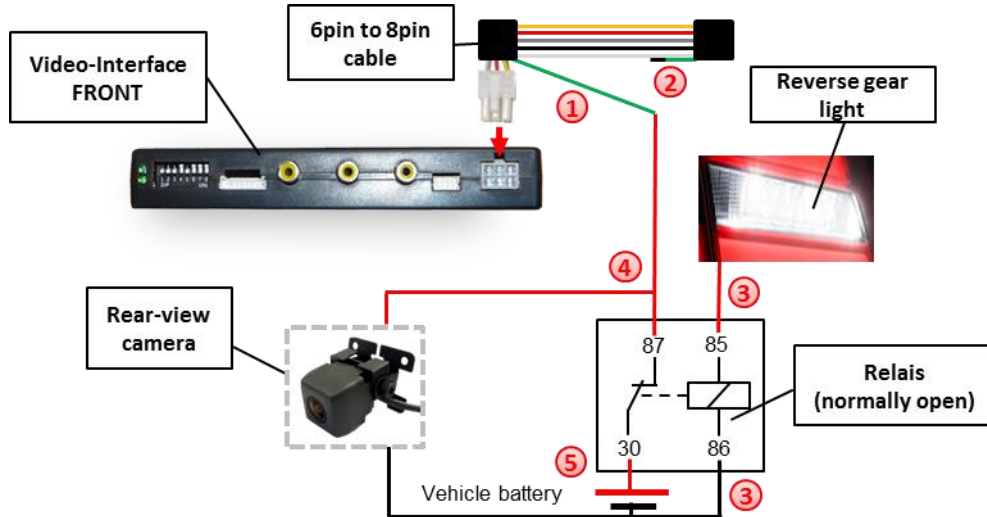

- ① Cut the green cable of the 6pin to 8pin cable close to the at the black 8pin connector.
- ② Isolate the short end of the green wire (CAN-box side).
- ③ Connect reverse gear light signal/power to coil (85) and ground to coil (86) of relais.
- ④ Connect rear-view camera power and green wire (video interface side) of 6pin to 8pin cable to output (87) of relay.
- ⑤ Connect permanent battery power to input (30) of relay.

2.6.1.2. Video signal connection

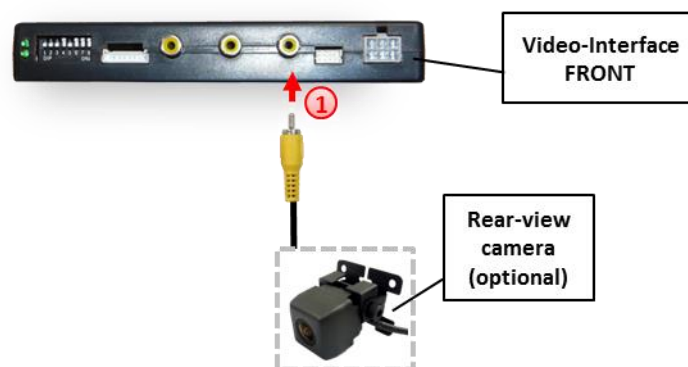

- ① Connect the video-RCA of the after-market rear-view camera to the female RCA port of the video-interface which is labeled as CAM.

Note: Picture settings for CAM input must be done in AV2.

2.6. Picture settings and guide lines

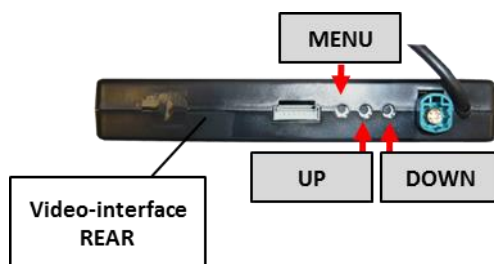

The picture settings are adjusted by the 3 buttons on the video-interface. Press the MENU button to open the OSD settings menu or to switch to the next menu item. Press UP and DOWN change the selected value. The buttons are embedded in the housing to avoid accidental changes during or after installation. Picture settings must be done separately for RGB, AV1 and AV2 while the corresponding input is selected and visible on the monitor. AV2 and CAM share the same settings which must be adjusted in AV2.

Note: The OSD menu is only shown when a working video source is connected to the selected video-input of the interface.

The following settings are available:

- Brightness
- Contrast
- Saturation
- Position H (horizontal)
- Position V (vertical)
- Guide Line (ON/OFF)

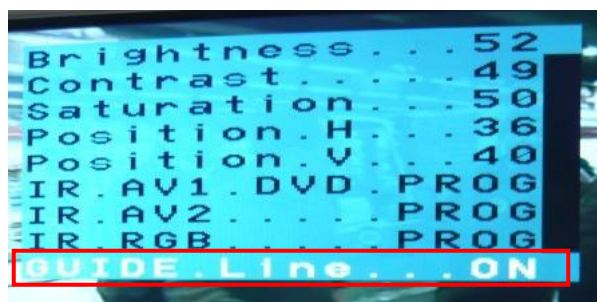

Note: If the CAN-box does not support the very vehicle, the guide-lines cannot be used.

3. Interface operation

3.1. By iDrive-buttons

Some of the iDrive-buttons can be used to execute interface functions.

Long press NAV-button (MAP-button) to switch the video source. Each repetition will switch to the next enabled input. If all inputs are enabled the order is:

Factory video → RGB-in → video IN1 → video IN2 → factory video →...

Inputs which are not enabled are skipped. If the audio cable is connected, when switching from video IN1 to video IN2, also the sound will be switched.

Press **CD- or RADIO-button** to return to the factory-video.

Note: The white wire of the 6pin cable can be used with a +5-12V pulse to switch the video-sources alternatively.



Long press OPTION-button or long push iDrive up to switch the picture format:

- 16:9
- 24:9
- PIP vertical
- PIP horizontal.

Note: Picture formats 24:9 and PIP horizontal are only available for ultra-wide screens 8.8"/10.2".

4. Specifications

BATT/ACC range	7V ~ 25V
Stand-by power drain	<10mA
Power	0.2A @12V
Power consumption	2.4W
Video input	0.7V~1V
Video input formats	PAL/NTSC
RGB-video amplitude	0.7V with 75 Ohm impedance
Temperature range	-40°C to +85°C
Weight	195g
Dimensions (box only) B x H x T	182 x 24 x 100 mm

CE 12V DC

5. Frequently asked questions

For any troubles which may occur, check the following table for a solution before requesting support from your vendor.

Symptom	Reason	Possible solution
No picture/black picture (factory picture).	Not all connectors have been reconnected to factory head-unit or monitor after installation.	Connect missing connectors.
	No power on CAN-bus box (all LED CAN-bus box are off).	Check power supply of CAN-bus box. Check CAN-bus connection of CAN-bus box.
	CAN-bus box connected to CAN-bus in wrong place.	Refer to the manual where to connected to the CAN-bus. If not mentioned, try another place to connect to the CAN-bus.
	No power on video-interface (all LED video-interface are off).	Check whether CAN-bus box delivers +12V ACC on red wire output of 8pin to 6pin cable. If not cut wire and supply ACC +12V directly to video-interface.
No picture/black picture/white picture (inserted picture) but factory picture is OK.	No picture from video source.	Check on other monitor whether video source is OK.
	No video-source connected to the selected interface input.	Check settings dips 1 to 3 of video interface which inputs are activated and switch to corresponding input(s).
	LVDS cables plugged in wrong place.	Double-check whether order of LVDS cables is exactly connected according to manual. Plugging into head-unit does not work when the manual says to plug into monitor and vice versa.
Inserted picture totally wrong size or position.	Wrong monitor settings of video-interface.	Try different combinations of dips 7 and 8 of video-interface. Unplug 6pin power after each change.
Inserted picture double or 4 times on monitor.		
Inserted picture distorted, flickering or running vertically.	Video sources output set to AUTO or MULTI which causes a conflict with the interfaces auto detection.	Set video source output fixed to PAL or NTSC. It is best to set all video sources to the same standard.
	If error occurs only after source switching: Connected sources are not set to the same TV standard.	Set all video sources to the same standard.
	Some interfaces can only handle NTSC input.	Check manual whether there is a limitation to NTSC mentioned. If yes, set source fixed to NTSC output.
Inserted picture b/w.	Picture settings have not been adjusted.	Use the 3 buttons and the interface's OSD to adjust the picture settings for the corresponding video input.
Inserted picture qual. bad.		
Inserted picture size slightly wrong.		
Inserted picture position wrong.		
Camera input picture flickers.	Camera is being tested under fluorescent light which shines directly into the camera.	Test camera under natural light outside the garage.
Camera input picture is bluish.	Protection sticker not removed from camera lens.	Remove protection sticker.

Symptom	Reason	Possible solution
Camera input picture black.	Camera power taken directly from reverse gear lamp.	Use relay or electronics to "clean" reverse gear lamp power. Alternatively, if CAN-bus box is compatible with the vehicle, camera power can be taken from green wire of 6pin to 8pin cable.
Camera input picture has distortion.		
Camera input picture settings cannot be adjusted.	Camera input picture settings can only be adjusted in AV2 mode.	Set dip 3 of video-interface to ON (if not input AV2 is not already activated) and connect the camera to AV2. Switch to AV2 and adjust settings. Reconnect camera to camera input and deactivate AV2 if not used for other source.
Graphics of a car in camera input picture.	Function PDC is ON in the interface OSD.	In compatible vehicles, the graphics will display the factory PDC distance. If not working or not wanted, set interface OSD menu item UI-CNTRL to ALLOFF.
Chinese signs in camera input picture	Function RET or ALL is ON (function for Asian market) in the interface OSD.	Set interface OSD menu item UI-CNTRL to ALLOFF or PDCON.
Not possible to switch video sources by OEM button.	CAN-bus interface does not support this function for vehicle.	Use external keypad or cut white wire of 6pin to 8pin cable and apply +12V impulses for AV-switching.
Not possible to switch video sources by external keypad.	Pressed too short.	For video source switching a longer press of about 2.5 seconds is required.
	SW-version of interface does not support external keypad.	Use OEM-button or cut white wire of 6pin to 8pin cable and apply +12V impulses for AV-switching.
Interface does not switch to camera input when reverse gear is engaged.	CAN-bus interface does not support this function for the vehicles.	Cut the green wire of the 6pin to 8pin cable and apply +12V constant from reverse gear-lamp signal. Use relay to "clean" gear lamp power.
Interface switches video-sources by itself.	CAN-bus interface compatibility to vehicle is limited.	Cut the grey wire of 6pin to 8pin and isolate both ends. If problem still occurs, additionally cut the white wire of 6pin to 8pin cable and isolate both ends.

6. Technical Support

Please note that direct technical support is only available for products purchased directly from NavLinkz GmbH. For products bought from other sources, contact your vendor for technical support.

NavLinkz GmbH
distribution/tech dealer-support
Eurotec-Ring 39
D-47445 Moers

Tel +49 2841 949970
Email mail@navlinkz.de

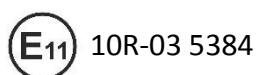

Made in China

