

This power amplifier is featured with an efficient protection system to prevent any damages like over-heating, overvoltage, short-circuit and DC at the loudspeaker output.
 Occuring an error the protection-LED will light in red. In order to check the problem, first turn down all levels of the head unit, afterwards turn it off.

AMPLIFIER IS NOT POWERED UP, NO LED IS LIGHTENING	<ul style="list-style-type: none"> - ground connection professional connected? - +12V / +24 V powercable professional connected? - remote cable professional connected? - fuses inserted and alright? - analyze voltage on the amplifier.
PROTECTION LED ILLUMINATES GREEN WHILE AMPLIFIER IS SOUNDLESS	<ul style="list-style-type: none"> - cinch cable or high level input alright and professional connected - loudspeaker professional connected? - head unit alright?
PROTECTION LED ILLUMINATES RED WHEN AMPLIFIER IS POWERED UP	<ul style="list-style-type: none"> - amplifier too hot? - short-circuit at the loudspeaker output? - short-circuit caused by loudspeaker cable with vehicle chassi (ground)? - input voltage too high (e.g.faulty generator)?
OVERHEATING (PROTECTION LED ILLUMINATES RED WHEN AMPLIFIER IS POWERED UP)	<ul style="list-style-type: none"> - impedance alright? - loudspeaker error? - adequate airflow of the amplifier? <p style="text-align: center;">! CAUTION !</p> <p style="text-align: center;">After cooling down, the amplifier turns on automatically.</p>
ERROR IN AMPLIFIER FUSE	<ul style="list-style-type: none"> - ground professional connected? - loudspeaker impedance alright? <p style="text-align: center;">! CAUTION !</p> <p style="text-align: center;">Make sure when changing fuses to use the same value.</p>
SOUND TOO LOW OR LOW-DISTORTED SOUND	<ul style="list-style-type: none"> - input level control "GAIN" is set to match the head unit? - output level control of the head unit alright? - loudspeaker error? - loudspeaker cable checked? - crossover frequencies has been properly set? (Check head unit, amplififier, DSP, soundprozessor, equalizer, frequency bandpassfilter...)
HIGH HISS-ENGINE NOISE IN SPEAKERS	<ul style="list-style-type: none"> - ground connection professional connected? - short-circuit caused by loudspeaker cable with vehicle chassi (ground)? - cinchcable (RCA) and/or loudspeaker cabel installed too close to the power connection cable? - cinch ground (RCA) of the head unit alright?

⚠ ATTENTION ⚠

Please contact your specialized dealer if the amplifier is still not working after it has been checked with the error list!

For warranty adjustement / repairs the original invoice has to be attached!

Opening the power amplifier is leading to a lost of warranty in either case!

Congratulation on your purchase of your new US-SERIES Active Subwoofer.

IMPORTANT: Before installation your power amplifier, we recommend to read the owner's manual carefully and to follow the instructions regarding connection and fitting exactly.

ATTENTION: Pay attention to advices and instructions of the car manufacturer.

IMPORTANT: Your proof of purchase is evidence of warranty claim for repair or replacement. Keep your proof of purchase, manual and original packaging.

ATTENTION: Use of sound components can impair your ability to hear necessary traffic sounds and may constitute a hazard while driving your automobile.

AUDIO SYSTEM GERMANY accepts no liability for hearing loss, bodily injury or property damage as a result of use or misuse of our products. We recommend installing the equipment by an authorized service center or dealer. A professional fitting and connection is the requirement for further warranty and perfect sound.

US SERIES BY AUDIO SYSTEM EQUIPMENT ACTIVE + 24 V

- 20cm Active-Underseat-Alu-Woofer with extremely heavy aluminum housing
- 2x Precision Passive Membranes (PPM)
- Extremely wide input sensitivity from 0,1 to 10 V
- **Multi-Way Protection Circuitry:** overheating, overcurrent, short circuitry & DC protection
- High-Power-Input (normally original radio) with automatically „Turn-On“
- Cable-High-Level-Input or Cinch-Input
- Cable-Set and **RTC** included



US SERIES BY AUDIO SYSTEM TECHNICAL DATA ACTIVE + 24 V

Power Supply Voltage	10 - 16 V / 22 - 28 V
RMS Power @ 2 Ohm Mono	200 W
Signal to Noise Ratio	> 92 dB
Low Pass Crossover (LPF)	50 - 150 Hz
Subsonic Filter	20 Hz
Phase Shift	0° / 180°
Frequency Response	20 Hz ~ 150 Hz (+/- 1 dB)
THD@RMS Watts	< 0,3%
Bass-Boost	0 bis +18 dB
Fuse Rating	25A
Input Sensitivity	0,1 V ~ 10 V (+/- 5%)
Dimensions	345(L) x 245(B) x 70(H) mm



US SERIES BY AUDIO SYSTEM TECHNICAL DATA ACTIVE + 24 V

Power Watt RMS	350 W
Frequency Response	20 Hz ~ 150 Hz (+/- 1 dB)
Impedance	2 Ohm
Dimensions	345(L) x 245(B) x 70(H) mm

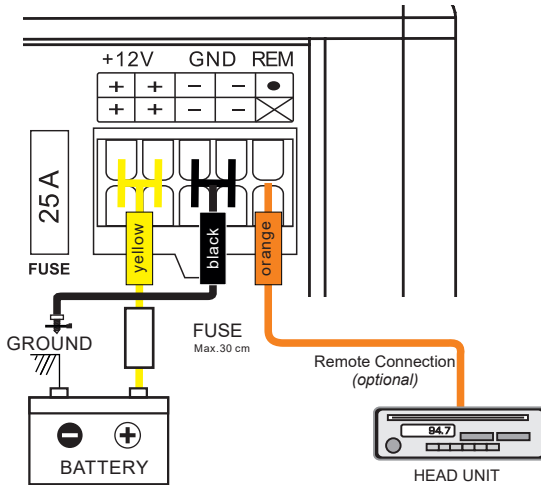

1. Battery disconnection

First disconnect the power supply of the vehicle. This works out the best by removing the ground cable of the battery.

2. Ground connection

Connect the GND (ground) connection of the amplifier with the car chassis. Keep this cable as short as possible (not longer than 50 cm) and use a suitable cross section (AWG size 6 - 10).

Make sure, that the connection with the vehicle chassis is free of paint, dirt and dust.

3. +12 V / 24 V Power connection:

Connect the +12 V / +24 V contact of the amplifier with the supply cable via a fuse directly to the vehicle battery. Keep in mind, that the length of the cable from fuseholder to vehicle battery has to be a maximum of 30 cm. Requirement for a perfect function of the amplifier is a qualitative high end fuse holder as well as a suitable cable cross section (AWG size 6 - 10). This fuse protects the amplifier and the vehicle against the possibility of a short circuit in the power cable.

4. Remote connection (optional):

You can optional connect the REM-terminal of the amplifier to the remote-output (automatic 12 V / 24 V antenna-output) of the head unit. Therefore use a 0,5 - 1,5 mm power cable.

⚠ ATTENTION ⚠

Please follow the instructions during the installation of your amplifier:

- Take care of a professional attachment. Pay attention, that no electrical cable, gas tank, hydraulic breakers or other components get damaged.
- There has to be enough cooling and air circulation. Avoid the installation in small closed boxes or close to heating parts.
- Protect the amplifier from fluids, wetness, heat and foreign material as well as from other influences.
- The amplifier is only to be built into vehicles with a 12 V / 24 V DC power supply.
- Never install the power supply cable with other original wires of the vehicle (gas cables), fan motors, brand control moduls etc.
- Install the signal cable (cinch cable) as well as the speaker cable far away of the power cables to avoid troubles with the music signal.
- The cables of your amplifier have to be installed, so that there is no danger of binding, squeezing or breaking.

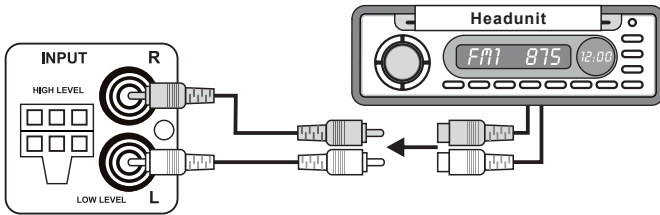

Der **US 08 ACTIVE + US 08 ACTIV 24V** have RCA inputs, which are connected by RCA cable with the preamp outputs of the control unit (Headunit, MP3 player, iPhone, iPad). If this is not possible (usually with an original radio, OEM), the loudspeaker outputs of the Headunit can be connected directly to the HIGH-LEVEL inputs and the switch can be set to "Auto Power". The amplifier turns on automatically when a signal is present.

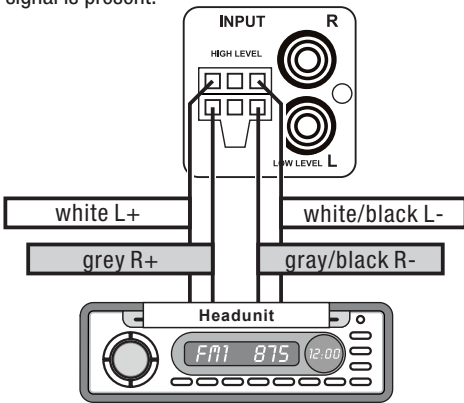

With the help of the INPUT GAIN controller, PHASE SHIFT, BASS BOOST and the variable frequency crossover (LOW PASS filter) you can adjust the power amplifier to the radio, to the conditions in the

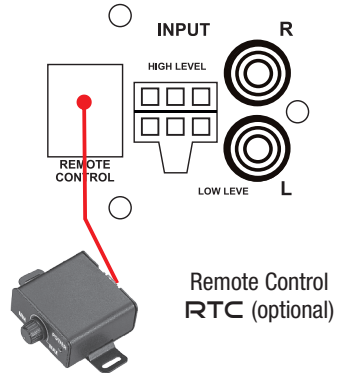

With the connected **RTC** (cable remote control), the subwoofer can be controlled by the driver's area.

US 08 ACTIVE +24V (NORMAL)

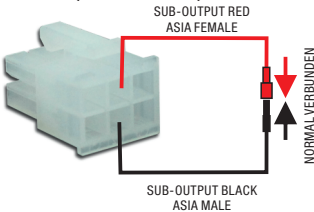

US 08 ACTIVE + 24V

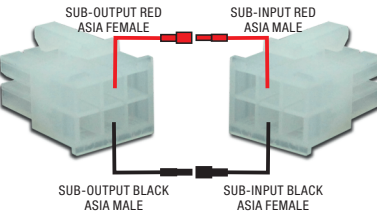

US 08 PASSIVE

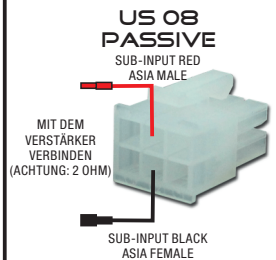

To connect the **US 08 PASSIVE** to the **ACTIVE**, connect the 2 Asia plug connections with one another (see figure). You can also operate the **US 08 PASSIVE** on another power amplifier by using the SUB inputs.

ATTENTION: Plug in the white Molex connector for single operation and connect both ASIA connectors.

In this regard, **AUDIO SYSTEM GERMANY** recommends to adjust your amplifier through a specialized service center, dealer or a specialist.